

GasAlert

EXTREME

Single Gas Detector

User Manual

BW Technologies
by Honeywell

Limited Warranty and Limitation Liability

BW Technologies LP (BW) warrants the product to be free from defects in material and workmanship under normal use and service for a period of two years, beginning on the date of shipment to the buyer. This warranty extends only to the sale of new and unused products to the original buyer. BW's warranty obligation is limited, at BW's option, to refund of the purchase price, repair or replacement of a defective product that is returned to a BW authorized service center within the warranty period. In no event shall BW's liability hereunder exceed the purchase price actually paid by the buyer for the Product.

This warranty does not include:

- a) fuses, disposable batteries or the routine replacement of parts due to the normal wear and tear of the product arising from use;
- b) any product which in BW's opinion, has been misused, altered, neglected or damaged, by accident or abnormal conditions of operation, handling or use;
- c) any damage or defects attributable to repair of the product by any person other than an authorized dealer, or the installation of unapproved parts on the product; or

The obligations set forth in this warranty are conditional on:

- a) proper storage, installation, calibration, use, maintenance and compliance with the product manual instructions and any other applicable recommendations of BW;
- b) the buyer promptly notifying BW of any defect and, if required, promptly making the product available for correction. No goods shall be returned to BW until receipt by the buyer of shipping instructions from BW; and
- c) the right of BW to require that the buyer provide proof of purchase such as the original invoice, bill of sale or packing slip to establish that the product is within the warranty period.

THE BUYER AGREES THAT THIS WARRANTY IS THE BUYER'S SOLE AND EXCLUSIVE REMEDY AND IS IN LIEU OF ALL OTHER WARRANTIES, EXPRESS OR IMPLIED, INCLUDING BUT NOT LIMITED TO ANY IMPLIED WARRANTY OF MERCHANTABILITY OR FITNESS FOR A PARTICULAR PURPOSE. BW SHALL NOT BE LIABLE FOR ANY SPECIAL, INDIRECT, INCIDENTAL, OR BASED ON CONTRACT, TORT OR RELIANCE OR ANY OTHER THEORY.

Since some countries or states do not allow limitation of the term of an implied warranty, or exclusion or limitation of incidental or consequential damages, the limitations and exclusions of this warranty may not apply to every buyer. If any provision of this warranty is held invalid or unenforceable by a court of competent jurisdiction, such holding will not affect the validity or enforceability of any other provision.

BW Technologies by Honeywell
Corporate Headquarters
2840 - 2nd Ave. SE
Calgary, AB
Canada T2A 7X9

BW Technologies by Honeywell
America
3279 West Pioneer Parkway
Arlington, TX
USA 76013

BW Technologies by Honeywell
Europe
5 Canada Close
Banbury, Oxfordshire
United Kingdom OX16 2RT

Table of Contents

Title	Page
Introduction	1
Contacting BW Technologies by Honeywell	2
Safety Information - Read First	2
Getting Started	5
Activating the Detector	9
Self-Test	9
Self-Test Pass	12
Self-Test Fail.....	12
Deactivating the Detector	13
Confidence Beep	13
User Options Menu	14
Exit	15
Clock Option	15
Passcode Protection Option	16
Enable Passcode Protection	16
Disable Passcode Protection.....	17
Deactivation Passcode Protection	17
Stealth Mode Option	18
Automatic Backlight Option.....	19
Latching Alarm Option	19
Automatic Oxygen (O ₂) Calibration Option	20
Calibration Past Due Option	21
Languages	21

Title	Page
Portuguese Option	21
Spanish Option	22
German Option	22
French Option	22
English Option	23
Datalogger Sampling Rate Option	23
Data Transfer Option	24
LAST and ALL Transfers	25
EVNT Transfer	25
Unsuccessful Transfer	25
Alarms	26
Computed Gas Exposures	28
Viewing Gas Exposures	28
Toxic Gases	28
Oxygen	28
Gas Alarm Setpoints	29
Stopping a Gas Alarm	29
Clearing Gas Exposures	30
Resetting Gas Alarm Setpoints	30
Sensor Alarm	30
Low Battery Alarm	31
Automatic Shutdown Alarm	31
Calibration and Setting Alarm Setpoints	32
Guidelines	32
Test Cap	33
Calibration	34
Start Calibration	34

Title	Page
Auto Zero	34
Auto Zero Fail	34
Passcode Protected	35
Set Span	35
Span	36
Setting the Calibration Due Date	37
Setting the TWA Alarm Setpoint	37
Setting the STEL Alarm Setpoint	38
Setting the Low Alarm Setpoint	38
Setting the High Alarm Setpoint	39
Verification	39
Datalog and Event Log	40
Datalog	40
Event Log	40
Maintenance	41
Replacing the Battery or Sensor	43
Replacing the Battery	43
Replacing the Sensor	43
Cleaning a Sensor Screen	44
Clearing a Sensor	45
WEEE Directive and Battery Directive	45
Removal and Disposal of the Battery	45
Troubleshooting	46
Replacement Parts and Accessories	49
Specifications	50
General Specifications for Datalogger Units	51

List of Figures

Title	Figure	Page
1.	GasAlert Extreme Detector	6
2.	Display Elements	7
3.	Test Cap	33
4.	Replacing the Battery or Sensor	41
5.	Rear Shell Seal	42
6.	Front Shell Seal	42

List of Tables

Table	Title	Page
1.	GasAlert Extreme Models	1
2.	International Symbols	4
3.	GasAlert Extreme Detector	6
4.	Display Elements	7
5.	Pushbuttons	8
6.	Alarms	26
7.	Computed Gas Exposures	28
8.	Gas Alarm Setpoints	29
9.	Factory Alarm Setpoints	30
10.	Test Cap	33
11.	Replacing the Battery or Sensor	41
12.	Rear Shell Seal	42
13.	Front Shell Seal	42
14.	Troubleshooting Tips	46
15.	Replacement Parts and Accessories	49

GasAlert Extreme

Introduction

Warning

To ensure your personal safety, read “Safety Information” before using the detector.

The GasAlert Extreme gas detector (“the detector”) warns of hazardous gas at levels above a factory set alarm setpoint. This product is a gas detector, not a measurement device.

The detector is a personal safety device. It is your responsibility to respond properly to the alarms.

Table 1 lists the GasAlert Extreme models and the gases monitored. This manual includes examples from each model.

Table 1. GasAlert Extreme Models

Model	Gas Monitored
GasAlert Extreme O ₂	Oxygen (% by volume)
GasAlert Extreme CO	Carbon monoxide (ppm) Low H ₂ sensitivity
GasAlert Extreme CO	Carbon monoxide (ppm)
GasAlert Extreme H ₂ S	Hydrogen sulfide (ppm) High range

Model	Gas Monitored
GasAlert Extreme H ₂ S	Hydrogen sulfide (ppm)
GasAlert Extreme PH ₃	Phosphine (ppm)
GasAlert Extreme SO ₂	Sulfur dioxide (ppm)
GasAlert Extreme Cl ₂	Chlorine (ppm)
GasAlert Extreme NH ₃	Ammonia (ppm)
GasAlert Extreme NH ₃	Ammonia (ppm) High range
GasAlert Extreme NO ₂	Nitrogen dioxide (ppm)
GasAlert Extreme HCN	Hydrogen cyanide (ppm)
GasAlert Extreme ETO	Ethylene oxide (ppm)
GasAlert Extreme ClO ₂	Chlorine dioxide (ppm)
GasAlert Extreme O ₃	Ozone (ppm)
GasAlert Extreme NO	Nitric oxide (ppm)

Contacting BW Technologies by Honeywell

To contact BW Technologies by Honeywell, call:

USA: 1-888-749-8878

Canada: 1-800-663-4164

Europe: +44 (0) 1295 700300

Other countries: +1-403-248-9226

Address correspondence to:

BW Technologies by Honeywell

2840 – 2 Avenue S.E.

Calgary, AB T2A 7X9

CANADA

Email us at: info@gasmonitors.com

Visit BW Technologies by Honeywell's website at:

www.gasmonitors.com

ISO 9001

Safety Information - Read First

Use the detector only as specified in this manual, otherwise the protection provided by the detector may be impaired.

International symbols used on the detector and in this manual are explained in Table 2.

Read the **Warnings** and **Cautions** on the following pages before using the detector.



Note

This instrument contains a lithium battery. Do not mix with the solid waste stream. Spent batteries should be disposed of by a qualified recycler or hazardous materials handler.

⚠ Caution

To avoid possible personal injury, adhere to the following:

- **Warning: Substitution of components may impair Intrinsic Safety.**
- **Warning: To prevent ignition of flammable or combustible atmospheres, disconnect power before servicing.**
- **Do not use the detector if it is damaged. Before using the detector, inspect the case. Look for cracks and missing parts.**
- **Use only a sensor specifically designed for the GasAlert Extreme model. Refer to [Replacement Parts and Accessories](#).**
- **Do not deactivate the detector during a work shift. Deactivating the detector resets the time-weighted average (TWA), short-term exposure limit (STEL), and maximum gas exposure values to 0. Refer to [Alarms](#).**
- **Ensure the sensor screen is not blocked.**
- **If the detector is damaged or parts are missing, contact [BW Technologies by Honeywell](#) immediately.**
- **If the detector has been disassembled, ensure the front and rear shells are properly aligned and fastened before activating the detector. Refer to [Maintenance](#).**
- **BW recommends to bump test the sensor, before each day's use, to confirm their ability to respond to gas by exposing the detector to a gas concentration that exceeds the alarm setpoints. Manually verify that the audible and visual alarms are activated. For detectors with the calibration feature, calibrate the sensor if the reading is not within the specified limits.**
- **Calibrate the detector before first-time use, and then at least once every 180 days. For HCN detectors, calibrate once every 30 days.**
- **Use only the Panasonic CR-2 battery. Refer to [Replacing the Battery or Sensor](#).**
- **To reduce the risk of ignition of a flammable atmosphere, batteries must only be changed in a safe area free of hazardous gas.**

⚠ Caution

To avoid possible damage to the detector, adhere to the following:

- Do not expose the detector to electrical shock and/or severe continuous mechanical shock.
- The oxygen GasAlert Extreme detector is classified by Underwriters Laboratories Inc. up to an atmosphere of 21% oxygen.
- Do not attempt to disassemble, adjust, or service the detector unless instructions for that procedure are contained in the user manual, and/or that part is listed as a replacement part. Use only BW Technologies by Honeywell replacement parts. Refer to [Replacement Parts and Accessories](#).
- The detector warranty will be voided if customer personnel or third parties damage the detector during repair attempts. Non-BW Technologies by Honeywell repair/service attempts void this warranty.

⚠ Attention

Pour éviter toute blessure possible, respectez ce qui suit :







- **Avertissement : Le remplacement d'un composant de l'appareil peut altérer sa sécurité intrinsèque.**
- **Avertissement : Pour éviter l'inflammation d'atmosphères inflammables ou combustibles, coupez l'alimentation électrique avant tout entretien.**
- **N'utilisez pas le détecteur s'il est endommagé. Avant d'utiliser le détecteur, inspectez le boîtier. Assurez-vous qu'aucune pièce ne manque et vérifiez l'absence de fissures.**
- **Utilisez uniquement un capteur spécialement conçu pour le modèle GasAlert Extreme. Reportez-vous à la section [Remplacement Parts and Accessories](#).**
- **Ne désactivez pas le détecteur pendant un quart de travail. Si vous désactivez le détecteur, les valeurs de la moyenne pondérée dans le temps (MPT), de la limite d'exposition (LECT) à court terme et d'exposition maximale aux gaz sont réinitialisées à 0. Reportez-vous à la section [Alarms](#).**
- **Assurez-vous que l'écran du capteur est verrouillé.**
- **Si le détecteur est endommagé ou que des pièces sont manquantes, contactez immédiatement [BW Technologies by Honeywell](#).**
- **Si le détecteur a été démonté, assurez-vous que les coques avant et arrière sont correctement alignées et serrées avant d'activer le détecteur. Reportez-vous à la section [Maintenance](#).**
- **Avant chaque utilisation quotidienne, BW recommande d'effectuer un test fonctionnel du capteur afin de vérifier qu'il réagit bien aux gaz présents, en exposant le détecteur à une concentration de gaz supérieure aux seuils d'alarme. Vérifiez manuellement que les alarmes sonore et visuelle sont activées. Pour les détecteurs dotés de la fonction d'étalonnage, étalonnez le capteur si la valeur ne se trouve pas dans les limites spécifiées.**
- **Étalonnez le détecteur lors de la première utilisation, puis une fois tous les 180 jours. Pour les détecteurs HCN, étalonnez-les tous les 30 jours.**
- **Utilisez uniquement la batterie Panasonic CR-2PE/BN. Reportez-vous à la section [Replacing the Battery or Sensor](#).**
- **Afin de réduire le risque d'inflammation d'une atmosphère inflammable, les batteries doivent être changées dans un lieu sûr exempt de gaz dangereux.**

⚠ Attention

Pour éviter d'endommager le détecteur, respectez ce qui suit :

- **Ne soumettez pas le détecteur à des chocs électriques et/ou à d'importants chocs mécaniques continus.**
- **Le détecteur d'oxygène GasAlert Extreme est classifié conforme par Underwriters Laboratories Inc. jusqu'à une atmosphère contenant 21 % d'oxygène.**
- **N'essayez pas de démonter, d'ajuster ou d'entretenir le détecteur, sauf si les instructions pour cette procédure vous sont fournies dans le manuel d'utilisation et/ou si la pièce concernée est répertoriée comme pièce de rechange. Utilisez uniquement des pièces de rechange de BW Technologies by Honeywell. Reportez-vous à la section [Remplacement Parts and Accessories](#).**
- **La garantie du détecteur sera annulée si le personnel du client ou des tiers ont endommagé le détecteur pendant des tentatives de réparation. Les tentatives de réparation/d'entretien effectuées par des parties autres que BW Technologies by Honeywell entraîneront l'annulation de cette garantie.**

Table 2. International Symbols

Symbol	Meaning
	Classified to both U.S. and Canadian Safety standards by Underwriter's Laboratories, Inc.
	Conforms to European Union Directives
	European Explosives Protection
ATEX	Conforms to European ATEX Directives
IECEX	International Electrotechnical Commission Scheme for Certification to Standards for Electrical Equipment for Explosive Atmospheres
EAC Ex	Conforms to Russian Custom Union Certification and Declaration
	Conforms to Korea Testing Laboratory (KTL) Certification
	Conforms to Brazilian InMetro Certification
	Australian Regulatory Compliance Mark (RCM)

Getting Started

The items listed below are included with the detector. If the detector is damaged or parts are missing, contact the place of purchase immediately.

- 3 V lithium CR2-series battery
- GasAlert Extreme O₂ model: O₂ sensor;
GasAlert Extreme CO model: CO sensor
(low H₂ sensitivity);
GasAlert Extreme CO model: CO sensor;
GasAlert Extreme H₂S model: H₂S sensor (high range);
GasAlert Extreme H₂S model: H₂S sensor;
GasAlert Extreme PH₃ model: PH₃ sensor;
GasAlert Extreme SO₂ model: SO₂ sensor;
GasAlert Extreme Cl₂ model: Cl₂ sensor;
GasAlert Extreme NH₃ model: NH₃ sensor;
GasAlert Extreme NH₃ model: NH₃ sensor (high range);
GasAlert Extreme NO₂ model: NO₂ sensor;
GasAlert Extreme HCN model: HCN sensor;
GasAlert Extreme ETO model: ETO sensor;
GasAlert Extreme ClO₂ model: ClO₂ sensor;
GasAlert Extreme O₃ model: O₃ sensor;
GasAlert Extreme NO model: NO sensor.
- Test cap and hose

The detector is shipped with the battery and sensor installed. To order replacement sensors and accessories, refer to [Replacement Parts and Accessories](#).

To become familiar with the features and functions of the detector, study the following figures and tables:

- Figure 1 and Table 3: GasAlert Extreme Detector
(describes the detector's components).
- Figure 2 and Table 4: Display Elements
(describes the LCD screen and icons).
- Table 5: Pushbuttons
(describes the buttons on the detector).

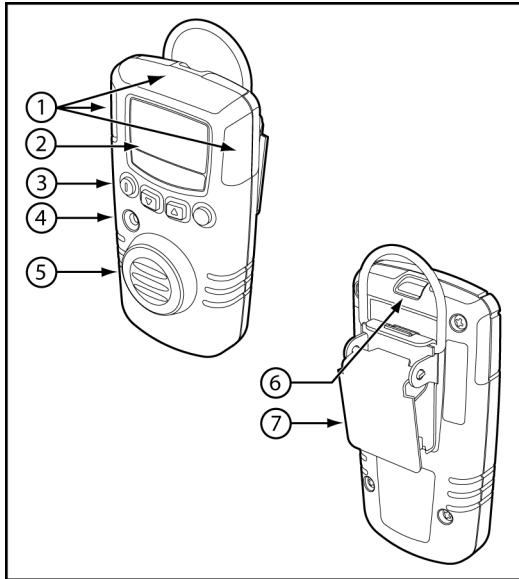

Figure 1. GasAlert Extreme Detector

Table 3. GasAlert Extreme Detector

Item	Description
1	Visual alarm indicators (LEDs)
2	Liquid crystal display (LCD)
3	Pushbuttons
4	Audible alarm
5	Sensor and sensor screen
6	Infrared (IR) communication port
7	Alligator clip

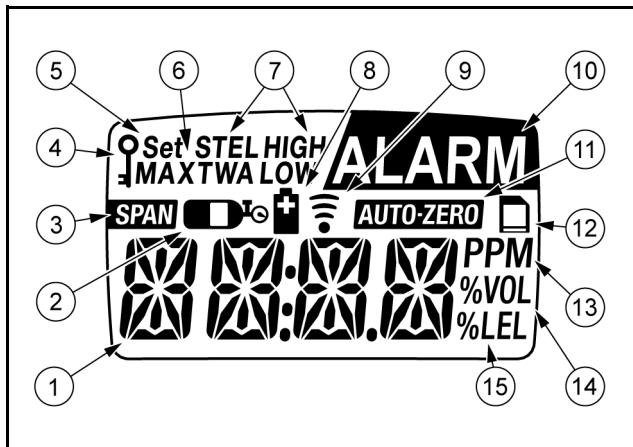

Figure 2. Display Elements

Note





















When enabled, the backlight option automatically activates for 3 seconds whenever there is insufficient light to view the LCD. Press and hold (until the backlight activates) any button to activate the backlight for 6 seconds. The detector is shipped with the backlight option enabled.

The backlight does not operate when stealth mode is enabled.

Table 4. Display Elements

Item	Description
1	Numeric value
2	Gas cylinder
3	Automatically span sensor
4	Passcode lock
5	Set alarm setpoints and user options
6	Maximum gas exposure
7	Alarm conditions
8	Battery
9	Data transmission
10	Alarm or alarm setpoint
11	Automatically zero sensor
12	Optional datalogger indicator
13	Parts per million (ppm)
14	Percentage by volume (% vol.)
15	Percentage by lower explosive limit (% LEL) (future use)

Table 5. Pushbuttons

Pushbutton	Description
	<ul style="list-style-type: none"> To activate the detector, press . To enable/disable the confidence beep, while the detector is deactivated press and hold . While holding , press  to enable or disable the confidence beep during start-up. To deactivate the detector, press  and hold until OFF displays (5 seconds). If the detector is passcode protected to prevent deactivation, PASS will display. A passcode must be entered to deactivate the detector. For more information, refer to Deactivation Passcode Protection.
	<ul style="list-style-type: none"> To decrement the displayed value or to scroll down, press . To enter the user options menu, press  and  simultaneously and hold until OPTN and then EXIT displays (5 seconds). To initiate calibration and set alarm setpoints, press and hold  and  simultaneously until CAL. displays.
	<ul style="list-style-type: none"> To increment the displayed value, press . To view the TWA, STEL and maximum (MAX) gas exposures, press  and  simultaneously.
	<ul style="list-style-type: none"> To save a displayed value, press . To clear TWA, STEL, and maximum (MAX) gas exposures, press and hold  for 6 seconds. To acknowledge a latched alarm, press .

Activating the Detector

To activate the detector, press  in a safe area, free of hazardous gas.

Self-Test

When the detector is activated, it performs several self-tests. Confirm the following tests occur.

Note





The following tests are listed in the order they are automatically performed on the detector.

1. **Display Elements Test:** The LCD displays all screen elements.



2. **Alarm Function Test:** The detector beeps, the LEDs flash, the backlight activates briefly, and the detector vibrates.
3. **Battery Test:** The detector tests the batteries. If the battery voltage is too low to continue, the detector performs an automatic shutdown. Refer to [Automatic Shutdown Alarm](#).

4. **Date and Time:** The LCD displays the date and time automatically in the following order.

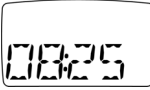
	Year: The LCD displays the current year (20XX).
	Month: JAN, FEB, MAR , etc.
	Day of the month: (1 to 31)
	Day of the week: MON, TUE, WED , etc.
	Hour/Minute: 00:00 hours to 23:59 hours

To adjust the date or time, refer to [Clock Option](#).

5. **Sensor Test:** The detector tests the sensor. If the sensor test fails, the detector beeps slowly, the LEDs flash slowly, and **ALARM** flashes.



If the sensor test passes, the self-test continues.

6. **Gas Type:** The LCD displays the type of gas the detector is manufactured to monitor.



Refer to Table 1 for the type of gases monitored.

If the battery is low, the LCD displays the low battery icon and the self-test continues.

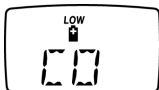

7. **TWA Alarm Setpoint:** The LCD displays the TWA alarm setpoint.



Note

The TWA alarm setpoint screen does not apply to O₂ detectors.

8. **STEL Alarm Setpoint:** The LCD displays the STEL alarm setpoint.



Note

The STEL alarm setpoint screen does not apply to O₂ detectors.

9. **Low Alarm Setpoint:** The LCD displays the low alarm setpoint.



10. **High Alarm Setpoint:** The LCD displays the high alarm setpoint.



11. **Calibration Due Test:** The LCD displays the calibration due date.

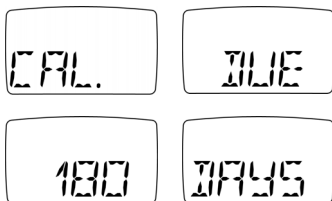

The LCD displays the number of days remaining before the detector must be calibrated. For more information, refer to [Calibration](#).

If calibration is past due, **CAL. PAST** displays.



Press to acknowledge the warning message.

If the calibration past due option is enabled or disabled, one of the following two events will occur.

- **Calibration Past Due Disabled:** If the detector is not passcode protected and after the **CAL. PAST** message is acknowledged, the detector continues the self-test and then enters normal operation.
- **Calibration Past Due Enabled:** If the detector is passcode protected and when **CAL. PAST** displays, press to acknowledge the message and to access the **PASS** screen. If required, refer to [Passcode Protection Option](#).



Press or to scroll to the required passcode, and press within 10 seconds to confirm the selection. The detector enters normal operation.

Note

Calibrate the detector before continuing operation.

If the passcode is not confirmed within 10 seconds or the passcode is incorrect, the detector beeps eight times, the LEDs flash 8 times, and the LCD displays the following screen.



The detector then automatically deactivates.

12. **Bump Test Fail:** If a previous bump test failed, the detector beeps, vibrates, and **BUMP FAIL** displays..

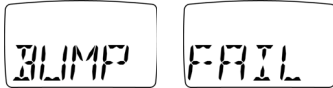

Press  to acknowledge the alarm.

Note

Bump test the detector before continuing operation.

For information regarding bump tests, refer to the *MicroDock II User Manual*.

Self-Test Pass

If the detector passes the self-test, it enters normal operation. The LCD displays the ambient gas reading.



The detector begins recording immediately. It records the

- maximum (MAX) gas exposure,
- the short-term exposure levels (STEL), and
- calculates the time-weighted average (TWA).

Self-Test Fail

If the detector fails the self-test, refer to [Troubleshooting](#).

Deactivating the Detector

Note

If Deactivation Passcode Protection is enabled, the detector cannot be disabled without entering a passcode first. **PASS** displays immediately after **OFF**, refer to [Deactivation Passcode Protection](#). This option can only be enabled at the factory and cannot be disabled by the customer.

To deactivate the detector, complete the following:

1. Press and hold  until **OFF** displays (approximately 5 seconds).



2. The detector beeps and vibrates four times, the LEDs flash four times, and then the detector deactivates.

Note

If  is not held down until **OFF** displays, the detector will remain activated.

Confidence Beep

The confidence beep provides continuous confirmation that the detector is operating properly. When the confidence beep is enabled, the detector beeps every 5 seconds.



The confidence beep can be enabled or disabled during start-up.

Note

The detector is shipped with the confidence beep disabled.

Enabling the confidence beep decreases battery life.

To enable/disable the confidence beep, complete the following:

1. Ensure the detector is deactivated.
2. Press and hold . While holding , press .

When the confidence beep option is enabled, the detector automatically begins beeping when activated.

When the confidence beep option is enabled in stealth mode, the detector vibrates one time every 60 seconds. For more information refer to [Stealth Mode Option](#) and [Alarms](#).

Note

If confidence beep is enabled and a low battery alarm occurs, the confidence beep deactivates.



User Options Menu

Note

When selecting a user option, **Set** flashes and the LCD displays the opposite of what is currently enabled.



To access the user options menu, complete the following:

1. Press and hold  and  simultaneously until **OPTN** displays and then release the buttons.



The detector beeps and vibrates four times and the LEDs flash four times while accessing the user options menu.

If the passcode protection is not enabled, the **EXIT** screen automatically displays.

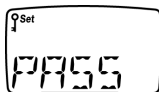

If the detector is passcode protected, the following screen displays.





2. Press  or  to scroll to the required passcode. Press  to confirm the selection and access the **EXIT** screen.

Note

If the passcode is not confirmed within 10 seconds, **NO** displays and the detector returns to normal operation.





3. From the **EXIT** screen, press  or  to scroll through the user options.
4. Press  to select a displayed option.

Note

As a safety precaution, if an option is not selected within 20 seconds the detector automatically returns to normal operation.

When the required activities have been performed for a selected option, the EXIT screen automatically displays.

5. Press  or  to select another option or press  to exit the user options menu and return to normal operation.

Exit

When entering user options, the **EXIT** screen displays immediately following the options (**OPTN**) screen. The LCD automatically returns to the **EXIT** screen after a user option has been accessed.







From the **EXIT** screen, use  or  to scroll to additional user options.

Or

Press  to exit user options and return to normal operation.

Clock Option



The clock (**CLCK**) option sets the date (year/month/day/day of the week) and time (hour/minute) of the detector. To set the time or date, complete the following:

1. From the **EXIT** screen, press  or  to scroll to the **CLCK** option.
2. Press  to select the option and access the first date/time option, the year. **Set** and the last two digits of the year continually flash.
3. Press  or  to scroll to the required year and press  to confirm the selection.

Or





To bypass the year, press  to retain the current value and automatically proceed to the month screen.

4. Repeat step #3 for the remaining date/time changes.

5. Press  or  to select another option or press  to exit the user options menu and return to normal operation.

Note

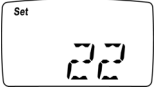
The time and date values can only be changed in the order they are presented in this table. To bypass any setting, press . The detector automatically retains the current value and proceeds to the next date/time option.

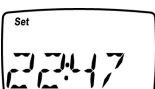
	Year: Requires only the last two numerals of the year (00-99).
	Month: Scroll to select the required month (JAN, FEB, MAR, etc.).
	Day: Scroll to select the required day (1-31). For months with 30 days (1-30) is available. For February, (1-28 & 29) is available.
	Day of the week: Scroll to select the required day (MON, TUE, WED, etc.).
	Time: The hour value flashes first. Scroll to select (0:00 hours. to 23:59 hours).

Note

If a value is not bypassed by pressing  within 10 seconds, the detector automatically proceeds to the next date/time option. If the Time Minute value was not bypassed, the detector automatically proceeds to the **Exit** screen.

If a new value is selected but not confirmed by pressing  within 10 seconds, **NO** displays and the detector proceeds to the next date/time option. If a new Time Minute value was selected but not confirmed, the detector automatically proceeds to the **Exit** screen.



Passcode Protection Option

The passcode protection option (**PASS**) prevents unauthorized access to the user options and the calibration/set alarm setpoint functions.

The passcode protection option can be enabled or disabled.

Note



The detector is shipped with the passcode protection option disabled.

Enable Passcode Protection





To enable passcode protection, complete the following:

Note



The passcode is provided on a separate card inside the shipping container.

1. From the **EXIT** screen of the user options menu, press  or  to scroll to the **PASS** option.

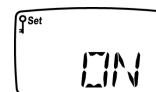

2. Press  to select the option.
3. **Set** and **PASS** continually flash. Press  or  to scroll to the required passcode, and press  to confirm the selection.
4. The **ON** screen displays and flashes continually. Press  to confirm. The LCD then returns to the **EXIT** screen.



5. Press  or  to select another user option, or press  to exit the user options and return to normal operation.



Note

If an incorrect passcode is selected or a correct passcode is not confirmed within 10 seconds, **NO** displays and the LCD returns to the **EXIT** screen.







Disable Passcode Protection

When the detector is passcode protected, the key icon displays continually. To disable the passcode protection option, complete the following:

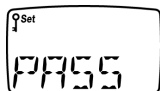
1. Press and hold  and  simultaneously to access the user options menu.





The **OPTN** screen displays briefly before the flashing passcode screen displays.





2. Press  or  to scroll to the required passcode and press  to confirm. The following **EXIT** screen displays.





The key icon indicates that the passcode protection is currently enabled.

3. Press  or  to scroll to the **PASS** option, and press  to select the option.
4. The LCD displays a flashing **OFF** screen. Press  to confirm the disabling option.

Note

To ensure if the passcode protection option is enabled/disabled, use  and  to toggle between the **ON** and **OFF** options. Display the desired option and press  to confirm the selection.

The LCD returns to the **EXIT** screen.

5. Press  or  to select another user option, or press  to exit the user options and return to normal operation.

Note

If a passcode value is not selected or confirmed by pressing  within 10 seconds, **NO** displays and the LCD returns to the **EXIT** screen.



Deactivation Passcode Protection

As a backup safety precaution, the deactivation passcode protection option can be enabled prevent unauthorized deactivation. A separate security passcode is required for this option and will be available to limited personnel only.

Note

The detector can be shipped with this option enabled permanently. This option can only be enabled at the factory and cannot be disabled by a customer.



The passcode must be entered every time the detector is deactivated.

To deactivate the detector, complete the following:

1. From normal operation, press and hold  to deactivate the detector.

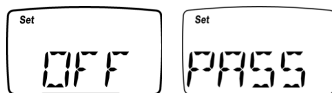
If the detector is passcode protected to prevent deactivation, **OFF** displays briefly and then **PASS** immediately displays.



2. Press  or  to scroll to the required security passcode. Press  to confirm the selection.

The detector then deactivates.

Stealth Mode Option

The stealth (**STLH**) mode option ensures that the detector is undetected in situations that require concealment. This option disables the

- audible alarms,
- visual alarms, and
- backlight.

Only the vibrator alarm remains enabled.

Note

The detector is shipped with stealth mode disabled.

To enable/disable the stealth mode, complete the following:

1. From the EXIT screen, press  or  to scroll to the **STLH** option.

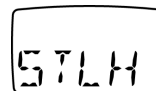



2. Press  to select the option. The LCD flashes either **ON** or **OFF**.



Enabled

Disabled

3. Press  or  to toggle between the **ON/OFF** options. Ensure the desired option is displayed and press  to confirm the selection.



The LCD returns to the **EXIT** screen.

If stealth mode has been enabled, the screen displays **STLH** continually unless

- functions are being performed,
- readings are not 0 ppm for toxics, or
- reading is not 20.9% vol for oxygen.

Note

The vibrator alarm is disabled at -20°C.

4. Press  or  to scroll to a new user option or press  to exit and return to normal operation.

Note

If the option is not confirmed by pressing  within 10 seconds, the detector returns to normal operation.

Automatic Backlight Option

The automatic backlight (**BKLT**) option enables or disables the backlight of the detector. When enabled, the backlight automatically activates for 3 seconds whenever there is insufficient light to view the LCD.

Press any button to activate the backlight for 6 seconds.





Note

The detector is shipped with the automatic backlight option enabled. The backlight option is not available in the user options menu when stealth mode is enabled.



To enable/disable the automatic backlight, complete the following:

1. From the **EXIT** screen, press  or  to scroll to the **BKLT** option.



2. Press  to select the option. The LCD flashes either **ON** or **OFF**.
3. Press  or  to toggle between the **ON/OFF** options. Ensure the desired option is displayed and press  to confirm the selection.

The LCD returns to the EXIT screen.

4. Press  or  to scroll to a new user option or press  to exit and return to normal operation.

Note

If the option is not confirmed by pressing  within 10 seconds, the detector returns to normal operation.

Latching Alarm Option

The latch alarm (**LTCH**) option ensures that an alarm persists until it is acknowledged by the user.

If enabled, during an alarm condition the latched alarms (**LTCH**) option causes the low and high gas alarms (audible, visual, and vibrator) to persist until the gas concentration is below the alarm setpoint and the alarms have been acknowledged by pressing .

The audible alarm can be temporarily deactivated (press ) for 30 seconds, but the LCD continues to display the peak concentration until the alarm condition no longer exists.

In stealth mode, the detector continues to vibrate until the alarm is acknowledged.





Note

The detector is shipped with the latching alarm option disabled.

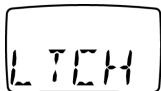

To enable/disable the latching alarm option, complete the following:

1. From the EXIT screen, press  or  to scroll to the **LTCH** option.



2. Press  to select the option. The LCD flashes either **ON** or **OFF**.
3. Press  or  to toggle between the **ON/OFF** options. Ensure the desired option is displayed and press  to confirm the selection.

The LCD returns to the **EXIT** screen.

4. Press  or  to scroll to a new user option or press  to exit and return to normal operation.

Note

If the option is not confirmed by pressing  within 10 seconds, the detector returns to normal operation.

Automatic Oxygen (O₂) Calibration Option

Note

For oxygen detectors only.



If the automatic oxygen (O₂) calibration option is enabled, ensure the detector is activated in safe area in normal (20.9%) oxygen atmosphere.

This option enables/disables the automatic oxygen (O₂) calibration. The O₂ calibration begins automatically during start-up after the calibration due screen displays.







Note

The detector is shipped with the automatic O₂ calibration option disabled.

To enable/disable the automatic O₂ calibration option, complete the following:

1. From the **EXIT** screen of the user options menu, press  or  to scroll to the **ACAL** option.



2. Press  to select this option. The LCD flashes either **ON** or **OFF**.
3. Press  or  to toggle between the **ON/OFF** options. Ensure the desired option is displayed and press  to confirm the selection.
The LCD returns to the **EXIT** screen.
4. Press  or  to scroll to a new user option or press  to exit and return to normal operation.

Note

If the option is not confirmed by pressing  within 10 seconds, the detector returns to normal operation.

Calibration Past Due Option



The calibration past due (**PAST**) option enables an automatic shutdown during start-up if the detector is past due for calibration.

Note





The detector is shipped with the calibration past due shutdown option disabled.

To calibrate a past due calibration detector, refer to [Calibration Past Due Enabled](#) in [Self-Test](#).

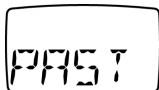

To enable/disable the calibration past due automatic shutdown option, complete the following:

1. From the **EXIT** screen of the user options menu, press  or  to scroll to the **PAST** option.



2. Press  to select the option. The LCD flashes either **ON** or **OFF**.
3. Press  or  to toggle between the **ON/OFF** options. Ensure the desired option is displayed and press  to confirm the selection.

The LCD returns to the **EXIT** screen.

4. Press  or  to scroll to a new user option or press  to exit and return to normal operation.

Note

If the option is not confirmed by pressing  within 10 seconds, the detector returns to normal operation.

Languages



The LCD can display text in five different languages. Refer to the following language options.

Portuguese Option

The Portuguese (**PORT**) option enables the LCD to display text in Portuguese.

Note



If the multi-language option is included, the detector is shipped with English selected as the default language.

1. From the **EXIT** screen of the user options menu, press  or  to scroll to the **PORT** option.

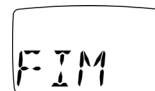

2. Press  to select the option. The LCD then displays the Portuguese exit screen.





3. Press  or  to scroll to another user option or press  to exit and return to normal operation.

Spanish Option

The Spanish (**ESPA**) option enables the LCD to display text in Spanish.

Note

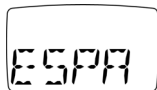

If the multi-language option is included, the detector is shipped with English selected as the default language.

1. From the **EXIT** screen of the user options menu, press  or  to scroll to the **ESPA** option.



2. Press  to select the option. The LCD then displays the Spanish exit screen.





3. Press  or  to scroll to another user option or press  to exit and return to normal operation.

German Option

The German (**DEUT**) option enables the LCD to display text in German.

Note



If the multi-language option is included, the detector is shipped with English selected as the default language.

1. From the **EXIT** screen of the user options menu, press  or  to scroll to the **DEUT** option.



2. Press  to select the option. The LCD then displays the German exit screen.





3. Press  or  to scroll to a new user option or press  to exit and return to normal operation.

French Option

The French (**FRAN**) option enables the LCD to display text in French.

Note



If the multi-language option is included, the detector is shipped with English selected as the default language.

1. From the **EXIT** screen of the user options menu, press  or  to scroll to the **FRAN** option.



2. Press  to select the option. The LCD then displays the French exit screen.





3. Press  or  to scroll to another user option or press  to exit and return to normal operation.

English Option

The English (**ENGL**) option enables the LCD screens to display text in English.

Note



If the multi-language option is included, the detector is shipped with English selected as the default language.

1. From the **EXIT** screen of the user options menu, press  or  to scroll to the **ENGL** option.



2. Press  to select the option. The LCD then displays the English exit screen.



3. Press  or  to scroll to another user option or press  to exit and return to normal operation.



Datalogger Sampling Rate Option

The datalogger sampling rate (**RATE**) option defines how often the detector records a datalog. The datalogger sampling rate ranges from **1** to **60** seconds.

Note

*The detector is shipped with a datalogging sampling rate of **5** seconds.*



To adjust the datalogger sampling rate, complete the following:



1. From the **EXIT** screen of the user options menu, press  and  to scroll to the **RATE** option.



2. Press  to select the option and display the sample rate screen.



3. The sample rate screen displays the current selected rate. Press  or  to scroll to a new rate and press  to save the new value.

- Press  or  to scroll to another user option or press  to exit and return to normal operation.

Note

If a datalogging sample rate value is not selected or confirmed by pressing  within 10 seconds, **NO** displays and the LCD displays the **EXIT** screen.



Data Transfer Option

The data transfer (**SEND**) option transfers the datalog/event log information from the detector to a PC.



Note

An IR DataLink (or other BW accessory) is required to transfer the data from the detector to a PC.

To transfer data, complete the following:

- Connect the IR DataLink (or other BW accessory) to the detector and the PC.











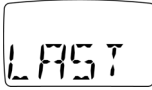

Refer to the *IR DataLink Instruction Sheet*.

- From the **EXIT** screen of the user options menu, press  or  to scroll to the **SEND** option.



- Press  to select the option and to access the data transfer option screens.

- Select one of the following options to transfer data.

	Press  or  to scroll to the event (EVNT) option. Press  to automatically transfer all events.
	Press  or  to scroll to the last (LAST) option. Press  to automatically send all of the datalogs since the last datalog download.
	Press  or  to scroll to the all (ALL) option. Press  to automatically send all of the datalogs that are saved on the detector.

- When the data transfer is complete, the detector beeps and vibrates, and the LEDs flash. The LCD displays the **EXIT** screen.

LAST and ALL Transfers

If the **LAST** or **ALL** option is selected, the LCD displays a countdown and the data transmission icon to indicate that the detector is transferring data.



Note

The number at the beginning of the countdown depends upon the amount of data to transfer.

EVNT Transfer

If the **EVNT** option is selected, the event logs transfer immediately and the LCD displays the **EXIT** screen.

Unsuccessful Transfer

If the connection between the detector and the IR DataLink is disconnected during a transfer, **FAIL** displays.



The LCD then displays the **EXIT** screen.

1. From the PC, save the previously transferred data to ensure that it will not be deleted.
2. Repeat steps #3-5 of the [Data Transfer Option](#).
3. From the detector, select **LAST** to automatically resume the transfer from where it stopped sending.

Or

Select **ALL** to transfer all of the data again.

Alarms

Table 6 describes detector alarms and corresponding screen. During an alarm condition, the detector activates the backlight and the LCD displays the current ambient gas reading.

To change the factory-set alarm setpoints, refer to [Calibration and Setting Alarm Setpoints](#).

Table 6. Alarms













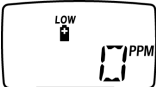

Alarm	Display	Alarm	Display
Low Alarm: <ul style="list-style-type: none"> • Slow beep • Slow flash • ALARM flashes • Slow vibrations 		TWA Alarm: <ul style="list-style-type: none"> • Slow beep • Slow flash • ALARM flashes • Slow vibrations 	
High Alarm: <ul style="list-style-type: none"> • Fast beep • Fast flash • ALARM flashes • Fast vibrations 		STEL Alarm: <ul style="list-style-type: none"> • Fast beep • Fast flash • ALARM flashes • Fast vibrations 	
Sensor Alarm: <ul style="list-style-type: none"> • Slow beep • Slow flash • ALARM flashes • Slow vibrations 		Low Battery Alarm: <ul style="list-style-type: none"> • One beep and one flash every 5 seconds, and one quick vibration every minute (when confidence beep is disabled). • If confidence beep is enabled no beeps, flashes, or vibrations • LOW  displays 	

Table 6. Alarms

Alarm	Display	Alarm	Display
Automatic Shutdown Alarm: (Low battery) <ul style="list-style-type: none"> • Eight beeps, flashes, and vibrations • LOW  displays 		Automatic Shutdown Alarm: (Calibration past) <ul style="list-style-type: none"> • Eight beeps, flashes, and vibrations 	
Automatic Shutdown Alarm: (After Automatic Shutdown Alarm) <ul style="list-style-type: none"> • No beep • No flash or vibrations •  displays for a short time 		Confidence Beep: <ul style="list-style-type: none"> • One beep every 5 seconds • One quick vibration per minute <p><i>Note</i></p> <p><i>If the detector enters low battery alarm, the confidence beep deactivates.</i></p>	

Note

The high alarm and STEL alarm have the same priority. A high alarm and/or STEL alarm overrides a low alarm and/or TWA alarm. To check STEL and TWA alarms specifically, press and hold  and  simultaneously.

The vibrator alarm is disabled at -20°C.

The high and low alarms deactivate when the gas concentration is lower than the low alarm setpoint. If the alarms are set to latch, alarms persist until the gas concentration is below the alarm setpoint and the alarms have been acknowledged by pressing . The TWA and STEL alarms deactivate by clearing the TWA and STEL peak exposure. Refer to [Clearing Gas Exposures](#).

Computed Gas Exposures

⚠ Warning

To avoid possible personal injury, do not deactivate the detector during a work shift. The detector automatically resets the TWA, STEL, and MAX gas exposures during start-up. If the detector is reactivated during a work shift, the new values will not reflect the entire work shift.



Table 7. Computed Gas Exposures

Gas Exposure	Description
TWA	Time-weighted average based on an 8-hour workday. Accumulated value.
STEL	Short-term exposure limit (STEL) to gas based on a 15-minute period. Accumulated value.
MAX*	Maximum (MAX) concentration encountered during a work shift.

*For oxygen, it is the highest or the lowest value from 20.9% encountered.

Viewing Gas Exposures

Toxic Gases

1. Press  and  simultaneously. The LCD displays the TWA gas exposure first.

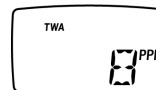

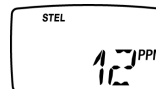

2. Then the LCD displays the STEL gas exposure.



3. Then the LCD displays the MAX gas exposure.



Oxygen

For oxygen detectors, press  and  simultaneously to view both the maximum low and maximum high levels of oxygen exposure.



Gas Alarm Setpoints

Table 8 describes the gas setpoints that trigger the gas alarms.

Table 8. Gas Alarm Setpoints

Alarm	Condition
Low alarm	Toxic gases: Ambient gas level above low alarm setpoint. O ₂ : ambient gas level may be set to above or below 20.9%.
High alarm	Toxic gases: ambient gas level above high alarm setpoint. O ₂ : ambient gas level may be set to above or below 20.9%.
TWA alarm	TWA above TWA alarm setpoint. (O ₂ : not applicable)
STEL alarm	STEL above STEL alarm setpoint. (O ₂ : not applicable)

Stopping a Gas Alarm

The low and high alarms deactivate when the ambient gas level returns to below the low alarm setpoint.

Note

If alarms are set to latch, the alarms deactivate after the gas concentration is lower than the low alarm setpoint and the alarms have been acknowledged by pressing .

The TWA and STEL alarms can be stopped either by

- *Clearing the MAX, TWA, and STEL peak exposures. Refer to [Clearing Gas Exposures](#).*

or

- *deactivating the detector and reactivating it again.*

If the detector is passcode protected to prevent deactivation, refer to [Deactivation Passcode Protection](#).

Caution

Follow all safety procedures as defined by your employer. Confirm with your supervisor before clearing TWA and STEL alarms.

Clearing Gas Exposures

The peak gas exposures automatically clear after deactivating the detector.

To clear the MAX, TWA, and STEL peak exposure readings immediately, press and hold  for 6 seconds. The detector beeps and vibrates two times to confirm that the exposures have been cleared.

Caution

Follow all safety procedures as defined by your employer. Confirm with your supervisor before clearing TWA and STEL alarms.

Resetting Gas Alarm Setpoints

Note

Standard factory alarm setpoints vary by region.

Table 9 lists the factory alarm setpoints.

To change the factory alarm setpoints, refer to [Calibration and Setting Alarm Setpoints](#).

Note

To disable an alarm, set the alarm setpoint to 0.

The ETO sensor is extremely cross sensitive and it responds strongly to CO.

Table 9. Factory Alarm Setpoints

Gas	TWA	STEL	Low	High
O ₂	N/A	N/A	19.5% vol.	22.5% vol.
CO (low H ₂)	35 ppm	200 ppm	35 ppm	200 ppm
CO	35 ppm	200 ppm	35 ppm	200 ppm
H ₂ S (high range)	10 ppm	15 ppm	10 ppm	15 ppm
H ₂ S	10 ppm	15 ppm	10 ppm	15 ppm
PH ₃	0.3 ppm	1.0 ppm	0.3 ppm	1.0 ppm
SO ₂	2.0 ppm	5.0 ppm	2.0 ppm	5.0 ppm
Cl ₂	0.5 ppm	1.0 ppm	0.5 ppm	1.0 ppm
NH ₃	25 ppm	35 ppm	25 ppm	50 ppm
NH ₃ (high range)	25 ppm	35 ppm	25 ppm	50 ppm
NO ₂	2.0 ppm	5.0 ppm	2.0 ppm	5.0 ppm
HCN	4.7 ppm	10.0 ppm	4.7 ppm	10.0 ppm
ETO	1.0 ppm	5.0 ppm	1.0 ppm	5.0 ppm
ClO ₂	0.1 ppm	0.3 ppm	0.1 ppm	0.3 ppm
O ₃	0.10 ppm	0.10 ppm	0.10 ppm	0.20 ppm
NO	25 ppm	25 ppm	25 ppm	25 ppm

Sensor Alarm

The detector tests for a missing or defective sensor during the activation self-test. Refer to [Troubleshooting](#).

Low Battery Alarm

If a low battery alarm occurs, follow your company's safety procedures.

The detector tests the battery upon activation and continuously thereafter. If the battery voltage is low, the detector activates the low battery alarm.

The low battery alarm continues until the battery is replaced or the battery power is almost depleted. If the battery voltage drops too low, the detector automatically deactivates.

Note

If the detector enters low battery alarm, the confidence beep deactivates.

⚠ Caution

Replace the battery in only a safe area, free of hazardous gas.

Automatic Shutdown Alarm

There are two situations when an automatic shutdown alarm occurs.

1. If the battery voltage is in immediate danger of falling below the minimum operating voltage, the detector beeps and vibrates eight times, and the LEDs flashes eight times. After 3 seconds, the LCD deactivates and the detector deactivates.

The LCD periodically displays  until the battery power is depleted.

To replace the battery, refer to [Replacing the Battery or Sensor](#).

Note

The low battery alarm continues for approximately 30 minutes before an automatic shutdown occurs.

2. If the calibration past due user option is enabled and the detector is past the calibration due date, the detector automatically deactivates.

Calibration and Setting Alarm Setpoints

Guidelines

When calibrating the detector, adhere to the following guidelines.

- Recommended gas mixture:
O₂: clean air, 20.9% vol.
CO (low H₂ sensitivity): 50 to 500 ppm balance N₂
CO: 50 to 500 ppm balance N₂
H₂S (high range): 10 to 100 ppm balance N₂
H₂S: 10 to 100 ppm balance N₂
PH₃: 1 to 5 ppm balance N₂
SO₂: 10 to 50 ppm balance N₂
Cl₂: 3 to 25 ppm balance N₂
NH₃: 20 to 100 ppm balance N₂
NH₃: (high range) 20 to 100 ppm balance N₂
NO₂: 5 to 50 ppm balance N₂
HCN: 5 to 20 ppm balance N₂
ETO: 5 to 50 ppm balance N₂
ClO₂: 0.1 to 1.0 ppm balance N₂
O₃: 0.1 to 1.0 ppm balance N₂
NO: 10 to 250 ppm balance N₂
- Before operating an ETO detector, allow the detector to stabilize at the temperature it will be operating in. After the detector has stabilized, zero the detector.
- It is necessary to periodically re-zero the ETO detector.
- To ensure accurate calibration, BW recommends using a premium-grade calibration gas approved by the National Institute of Standards and Technology (NIST).
- Do not use a gas cylinder beyond its expiration date.

- Before calibrating a new NO or ETO sensor, allow the sensor to stabilize for 2 hours in a safe area that is free of hazardous gas.
- Calibrate a new sensor before use. Allow the sensor to stabilize before starting calibration (used: 60 seconds; new: 5 minutes).
- Calibrate the detector at least once every 180 days (for HCN detectors calibrate at least once every 90 days), depending upon use and sensor exposure to poisons and contaminants.
- Calibrate the detector if the ambient gas display varies at start-up.
- It is best to calibrate the sensor before changing the alarm setpoints.
- Calibrate only in a safe area that is free of hazardous gas.
- To disable an alarm, set the alarm setpoint to zero.
- If a certified calibration is required, contact [BW Technologies by Honeywell](#).

Note

A generator must be used to calibrate O₃ and ClO₂ GasAlert Extreme sensors.

Test Cap

The calibration cap and hose are shipped with the detector for calibration.

Refer to Table 10 and Figure 3 for installation information.

Note

Only use the calibration cap during calibration.

Table 10. Test Cap

Item	Description
1	Test cap
2	Hose
3	Regulator
4	Gas cylinder

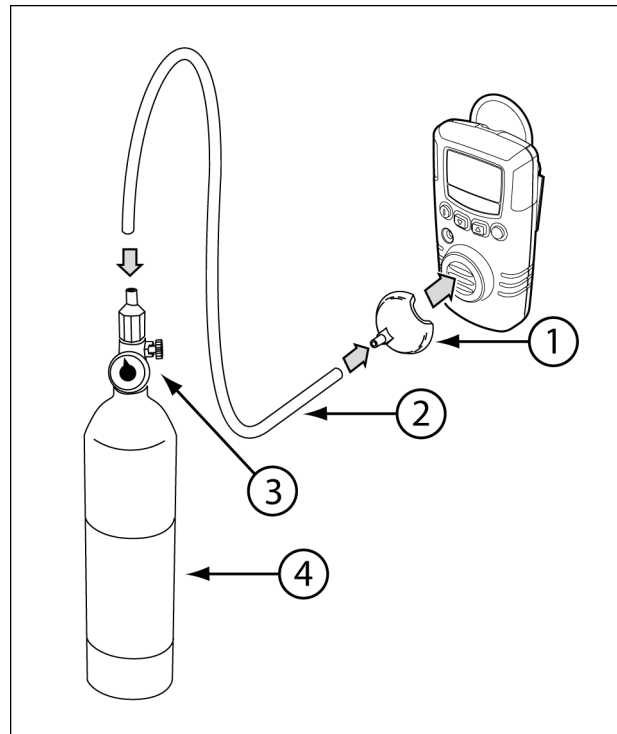



Figure 3. Test Cap

Calibration



Calibration requires several steps, some of which can be bypassed. A note is added to each option that can be bypassed.

Start Calibration

Note

To quit calibration at any point, press . The detector retains any saved values and the detector beeps and vibrates four times before returning to normal operation.

Calibrate O₂ in clean air only.

1. To enter calibration, in a safe area free of hazardous gas, press and hold  and  simultaneously as the detector beeps and vibrates four times, and the LEDs flash four times.

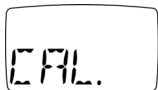

After the **CAL.** screen displays, the detector beeps one time and the auto zero screen displays.

Auto Zero

The auto zero function automatically zeroes the detector.



2. The LCD flashes **AUTOZERO** while the detector automatically zeroes the sensor. When the auto zero is complete the detector beeps twice.

Note

Do not apply the calibration gas until the LCD displays the flashing gas cylinder icon; otherwise, the detector auto zero will fail.

Auto Zero Fail

If the sensor fails auto zero, the following screen displays.

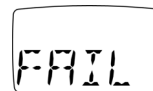



The detector then bypasses the sensor span and automatically proceeds to the alarm setpoints.

1. Press  to exit the alarm setpoint screens and to return to normal operation.
2. Restart the calibration procedures in a safe area that is free of hazardous gas. If auto zero fails a second time, deactivate and then reactivate the detector to test the sensors.
3. If the auto zero is successful and the passcode protection is disabled, the detector automatically proceeds to the auto span function.

Passcode Protected

After a successful auto zero, and if the passcode protected option is enabled, **PASS** displays. The passcode is required to access the auto span and alarm setpoint functions.



3. Press  or  to scroll to the required passcode and press  to confirm. For additional information, refer to [Passcode Protection Option](#).

If the correct code is confirmed by pressing  within 10 seconds, the detector beeps twice and automatically proceeds to the set span screen.



If the passcode is not confirmed within 10 seconds or the passcode is incorrect, **NO** displays.



The detector then beeps four times and automatically returns to normal operation.

Set Span



Note

To bypass the set span function, press  to automatically proceed to the span screen.

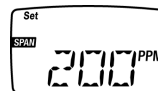
The set span function inputs a new calibration gas concentration value.



4. **Set SPAN** flashes.

Press  or  to scroll to the required gas concentration. The detector value must match the concentration value on the gas cylinder.

Note

*If a new value is selected but not confirmed within 10 seconds by pressing , the detector rejects the new value and **NO** displays. The detector beeps six times and retains the original value. The detector automatically proceeds to the span screen.*



5. Press  to save the new value and proceed to the span screen.



Span

Note

To bypass the span function, press  to automatically proceed to the alarm setpoint screens. If the span is bypassed, the calibration due date cannot be changed.

Verify that the calibration gas being used matches the span concentration values that are defined for the detector. For more information, refer to [Calibration Guidelines](#).

6. The set span screen displays a flashing .

Note

The flashing % does not display for oxygen (O_2) detectors.

7. Apply the calibration gas.
8. Apply gas to the sensor at a flow rate of 500 ml/min. (for NH_3 , Cl_2 , and ETO: 1000 ml/min.)
- The gas readings change as gas is applied to the sensor. When the detector senses a sufficient concentration of gas (approximately 30 seconds), the detector beeps once.
9. The detector then begins spanning the sensor as follows:
- NH_3 , Cl_2 , ClO_2 , O_3 , and ETO: 5 minutes to span
 - O_2 : 30 seconds to span
 - other gases: 2 minutes (approximately) to span.

The detector beeps three times when the span is complete.

Successful Span

If the span is successful, the LCD automatically displays the calibration due date screen.

Unsuccessful Span

If the detector fails to span a sensor successfully, **FAIL** displays.

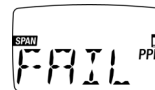

The detector vibrates and beeps, and the LEDs flash. Then the detector automatically proceeds to the alarm setpoint screens.

If the span fails confirm that

- gas is being applied to the sensor,
- the sensor is detecting a sufficient gas concentration within 30 seconds, and
- the gas concentration has not dropped significantly during the 2-minute span.

If the span is still unsuccessful, use a new gas cylinder.

If the span continues to be unsuccessful, replace the sensor. Refer to [Replacing the Battery or Sensor](#).

Setting the Calibration Due Date

After a successful calibration, the LCD displays the **CAL. DUE** screens and the number of days remaining before the next calibration.



Note

To bypass the calibration due notification, press \bigcirc . The detector automatically proceeds to the TWA alarm setpoint.

BW Technologies by Honeywell recommends that the detector be calibrated every 180 days (6 months). The detector is shipped with the factory default setting of 180 days.

10. Press \blacktriangle or \blacktriangledown to scroll to the required value (1 to 365).
11. Press \bigcirc to save the new value and automatically proceed to the TWA alarm setpoint screen.

Note

If a new value is selected but not confirmed within 10 seconds by pressing \bigcirc , the detector automatically retains the original value and **NO** displays. The detector proceeds to the TWA alarm setpoint.



Setting the TWA Alarm Setpoint

Note

To bypass and retain the current TWA alarm setpoint value, press \bigcirc . The detector automatically proceeds to the STEL alarm setpoint.

When the **CAL. DUE** function has been completed, the **Set TWA** alarm setpoint screen automatically displays.



12. Press \blacktriangle or \blacktriangledown to scroll to the required value.
13. Press \bigcirc to save the new value and proceed to the STEL alarm setpoint.

Note

If a new value is selected but not confirmed within 10 seconds by pressing \bigcirc , the detector automatically retains the original value and **NO** displays. The detector proceeds to the STEL alarm setpoint.



Setting the STEL Alarm Setpoint

Note

To bypass and retain the current STEL alarm setpoint value, press . The detector automatically proceeds to the low alarm setpoint.

When the TWA alarm setpoint value has been changed or bypassed, the **Set STEL** alarm setpoint screen displays.



14. Press or to scroll to the required value.
15. Press to save the new value and proceed to the low alarm setpoint.

Note

If a new value is selected but not confirmed within 10 seconds by pressing , the detector automatically retains the original value and **NO** displays. The detector proceeds to the low alarm setpoint.



Setting the Low Alarm Setpoint

Note

To bypass and retain the current low alarm setpoint value, press . The detector automatically proceeds to the high alarm setpoint.

When the STEL alarm setpoint value has been changed or bypassed, the **Set LOW** alarm setpoint screen displays.



16. Press or to scroll to the required value.
17. Press to save the new value and proceed to the high alarm setpoint.

Note

If a new value is selected but not confirmed within 10 seconds by pressing , the detector automatically retains the original value and **NO** displays. The detector proceeds to the high alarm setpoint.





Setting the High Alarm Setpoint

Note

To bypass and retain the current high alarm setpoint value, press . The detector then returns to the normal operation.

When the low alarm setpoint value has been changed or bypassed, the **Set HIGH** alarm setpoint screen displays.



18. Press  or  to scroll to the required value.
19. Press  to save the new value and return to normal operation.

Note

If a new value is selected but not confirmed within 10 seconds by pressing , the detector automatically retains the original value and **NO** displays. The detector proceeds to normal operation.



When calibration is complete, the detector beeps and vibrates four times, and the LEDs flash four times before returning to normal operation.

Verification

1. After calibration is complete and the detector is in normal operation, verify calibration by using a gas cylinder other than the one used for calibration.
2. The gas concentration should not exceed the sensor's detection range. Confirm that the LCD displays the expected concentration values.
3. To ensure that the reading is accurate, apply the verification gas for the same period of time as was applied to the sensor when it was calibrated.

Example: SO₂ span time was 2 minutes therefore, apply verification gas for 2 minutes.

Datalog and Event Log

The GasAlert Extreme datalogger version allows the detector to record various information so a report can be compiled.

Datalog

Datalog sampling rate is defined in the detector user options. To set the sample rate, refer to [Datalogger Sampling Rate Option](#).

The following information is recorded in a datalog:

- Date and time
- Detector serial number
- Type of gas the detector monitors
- Current gas reading
- Sensor status
- Detector status
- Passcode protect enabled/disabled
- STEL period setting (fixed to a 15 minute period)
- Confidence beep enabled/disabled
- Automatic backlight enabled/disabled
- Stealth mode enabled/disabled
- Latching alarm enabled/disabled
- Calibration past due user option enabled/disabled
- Language the detector is set to display

Event Log

Event log information is recorded when an event (i.e., an alarm) occurs. The following information is recorded in an event log:

- Detector serial number
- Type of exposure the detector that occurred
- Time the alarm started and ended
- Peak exposure of the alarm

Maintenance

To maintain the detector in good operating condition, perform the following basic maintenance as required:

- Calibrate, bump test, and inspect the detector at regular intervals.
- Maintain an operations log of all maintenance, calibrations, bump tests, and alarm events.
- Clean the exterior with a soft damp cloth. Do not use solvents, soaps, or polishes.
- Do not immerse the detector in liquids.

Table 11. Replacing the Battery or Sensor

Item	Description
1	Rear shell machine screws (4)
2	Rear shell
3	Battery
4	PCB machine screws (2)
5	PCB
6	Sensor
7	Sensor screen
8	Front shell

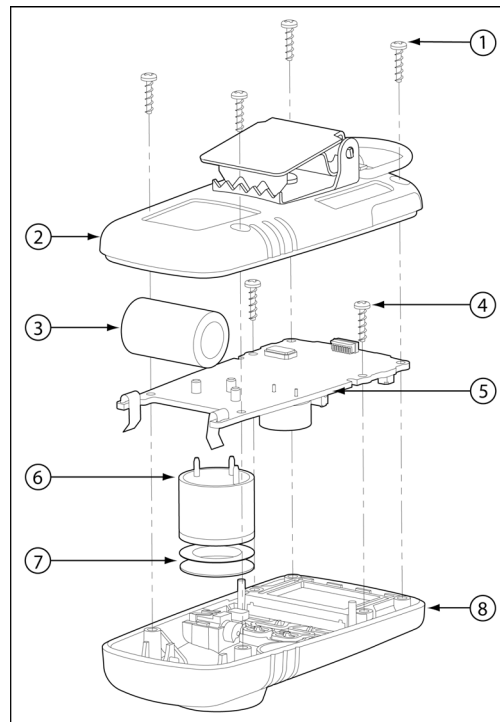

Figure 4. Replacing the Battery or Sensor

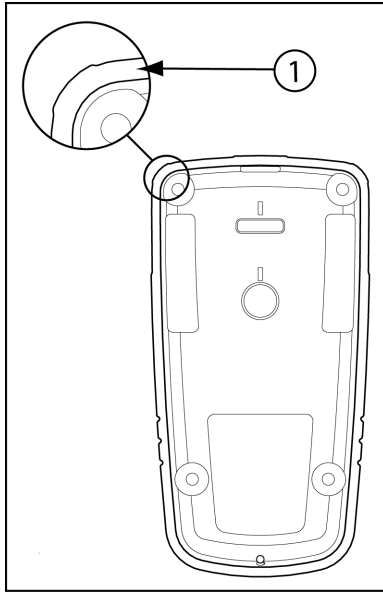

Figure 5. Rear Shell Seal

Table 12. Rear Shell Seal

Item	Description
1	Seal

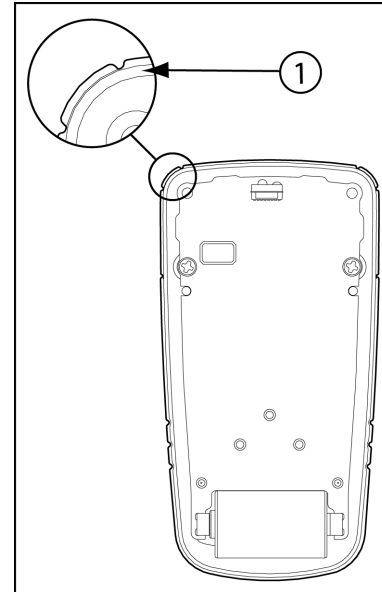

Figure 6. Front Shell Seal

Table 13. Front Shell Seal

Item	Description
1	Seal

Replacing the Battery or Sensor

Warning

To avoid possible personal injury, adhere to the following:

- Replace the battery in a safe area, free of hazardous gas immediately when the detector enters low battery alarm.
- Use only the Panasonic CR-2PE/BN battery.
- Use only the sensor specifically designed for the GasAlert Extreme model. Otherwise, the detector will not monitor the target gas. Refer to [Replacement Parts and Accessories](#).
- After replacing a sensor, allow the new sensor 5 minutes to stabilize before use. For an ETO or NO sensor, allow the new sensor 2 hours to stabilize before use.
- Do not expose a sensor to vapors of organic solvents such as paint fumes or organic solvents.

Note

When the battery is removed from the detector, the clock reverts back to the default value. Refer to [Clock Option](#).

To preserve the life of the battery, deactivate the detector when not in use.

For additional information regarding problems caused by a sensor requiring calibration or replacement, refer to [Troubleshooting](#).

Replacing the Battery

To replace a battery, complete the following. Refer to Figures 4, 5, and 6 and Tables 11, 12, and 13. Replace the battery in a safe area, free of hazardous gas.

1. Deactivate the detector.
2. Remove the four machine screws on the rear shell and remove the rear shell.
3. Remove the battery.

Warning

This instrument contains a lithium battery. Do not mix with the solid waste stream. Spent batteries should be disposed of by a qualified recycler or hazardous materials handler.

4. Insert the new battery.
5. Re-assemble the detector. When assembling the detector be aware of the following:
 - Clean the seal on the front and rear shells with a soft damp clean cloth. Do not use solvents, soaps, or polishes. Refer to Figures 5 and 6.
 - Ensure the front and rear shells are properly aligned to ensure a proper environmental seal.
 - Torque the screws to 3-4 in-lbs in a crisscross pattern to ensure a proper environmental seal. Do not overtighten.

Replacing the Sensor

To replace a sensor, complete the following. Refer to Figures 4, 5, and 6 and Tables 11, 12, and 13.

1. Deactivate the detector.
2. Remove the four machine screws on the rear shell and remove the rear shell.
3. Remove the two machine screws from the PCB.

4. Remove the PCB.
5. Replace the sensor.
Gently rock the sensor back and forth to remove a tightly held sensor.

Note

Allow the new sensor 5 minutes to stabilize before use. For a new ETO or NO sensor, allow the new sensor 2 hours to stabilize before use.

6. Re-assemble the detector. When assembling the detector be aware of the following:
 - Clean the seal on the front and rear shells with a soft damp clean cloth. Do not use solvents, soaps, or polishes. Refer to Figures 5 and 6.
 - Ensure the front and rear shells are properly aligned to ensure a proper environmental seal.
 - Torque the screws to 3-4 in-lbs in a crisscross pattern to ensure a proper environmental seal. Do not overtighten.

Cleaning a Sensor Screen

Clean or replace the sensor screen as required. If replacement sensor screens are required, refer to [Replacement Parts and Accessories](#).

To clean a removed sensor screen, complete the following. Refer to Figures 4, 5, and 6 and Tables 11, 12, and 13.

1. Deactivate the detector.
2. Remove the four machine screws on the rear shell and remove the rear shell.

3. Remove the two machine screws from the PCB.
4. Remove the PCB. Place the PCB on a clean surface.
5. Remove the screen.
6. Using a soft, clean brush, wash the screen with clean, warm water.
7. Insert the sensor screen with the shiny side facing the sensor grill.

Note

Ensure the screen is dry before inserting back into the detector.

8. Re-assemble the detector. When assembling the detector be aware of the following:
 - When inserting the sensor screen back into the detector, ensure the sensor screen is inserted with the shiny side facing the sensor grill.
 - Clean the seal around the edge of the front and rear shells with a soft damp clean cloth. Do not use solvents, soaps, or polishes. Refer to Figures 5 and 6.
 - Ensure the front and rear shells are properly aligned to guarantee a proper environmental seal.
 - Torque the screws to 3-4 in-lbs in a crisscross pattern to ensure a proper environmental seal. Do not overtighten.

Clearing a Sensor

Each sensor has a high degree of resistance to common vapors and gases. To clear a sensor, move the detector to a clean environment and wait 10 to 30 minutes.

Note

Do not expose a sensor to the vapors of inorganic solvents, such as paint fumes or organic solvents.

WEEE Directive and Battery Directive

Failure to comply with the following battery removal and disposal instructions may result in battery shorting, battery leakage, and/or other damage. Ensure a qualified technician completes the following procedures.

Removal and Disposal of the Battery

Only a qualified technician should complete the following procedure. Refer to [Figure 4](#), for parts of the detector.

Dispose of the battery according to local laws.

1. Press and hold  to deactivate the detector.
2. Remove the four machine screws on the rear shell and remove the rear shell.
3. Remove the two machine screws from the PCB.
4. Remove the PCB. Place the PCB on a clean, non-conductive surface.
5. Remove the battery.
6. Dispose of the battery according to local laws.

Troubleshooting

If a problem occurs, refer to the solutions provided in Table 14. If the problem persists, contact [BW Technologies by Honeywell](#).

Table 14. Troubleshooting Tips

Problem	Possible Cause	Solution
The detector does not activate.	No battery	Install a battery. Refer to Replacing the Battery or Sensor .
	Depleted battery	Replace the battery. Refer to Replacing the Battery or Sensor .
	Damaged or defective detector	Contact BW Technologies by Honeywell .
	Reversed battery	Reinstall the battery correctly.
The detector enters alarm mode immediately when it is activated.	Sensor needs to stabilize	Used sensor: wait 60 seconds. New sensor: wait 5 minutes.
	Low battery alarm	Replace the battery. Refer to Replacing the Battery or Sensor .
	Sensor alarm	Replace the sensor. Refer to Replacing the Battery or Sensor .
The start up self-test fails during one of the checks.	General fault	Contact BW Technologies by Honeywell .
	Alarm setpoints are incorrect	Reset the alarm setpoints. Refer to Resetting Gas Alarm Setpoints .

Table 14. Troubleshooting Tips

Problem	Possible Cause	Solution
The detector does not display a normal ambient gas reading after the activation self-test.	Target gas is present	Detector is operating properly. Use caution in suspect areas.
	Detector requires calibration	Calibrate the detector. Refer to Calibration and Setting Alarm Setpoints .
	Sensor not stabilized	Used sensor: wait 60 seconds. New sensor: wait 5 minutes.
The detector does not respond to the push-buttons.	Battery is depleted	Replace the battery. Refer to Replacing the Battery or Sensor .
	Detector is performing operations that does not require user input	Pushbutton operation restores automatically when the operation ends.
The detector does not accurately measure the gas.	Detector requires calibration	Calibrate the sensor. Refer to Calibration and Setting Alarm Setpoints .
	Detector is colder/hotter than ambient gas	Allow the detector to acquire ambient temperature before use.
	Sensor screen is blocked	Clean the sensor screen. Refer to Cleaning a Sensor Screen .
The detector does not enter alarm mode.	Alarm setpoint(s) are set incorrectly	Reset the alarm setpoints. Refer to Resetting Gas Alarm Setpoints .
	Alarm setpoint(s) set to zero	Reset the alarm setpoints. Refer to Resetting Gas Alarm Setpoints .
	Detector is in calibration mode	Complete calibration. Refer to Calibration and Setting Alarm Setpoints .

Table 14. Troubleshooting Tips

Problem	Possible Cause	Solution
The detector intermittently enters alarm mode without apparent reason.	Ambient gas levels are near alarm setpoint or the sensor is exposed to a puff of the target gas	Detector is operating normally. Use caution in suspect areas. Check MAX gas exposure reading.
	Alarms set incorrectly.	Reset the alarm setpoints. Refer to Calibration and Setting Alarm Setpoints .
	Missing or faulty sensor	Replace the sensor. Refer to Replacing the Battery or Sensor .
The detector automatically deactivates.	Automatic shutdown feature activated due to depleted battery	Replace the battery. Refer to <Replacing the Battery or Sensor .
Detector does not auto zero or calibrate.	Sensor may be expired	Change the sensor.
O ₂ sensor reading is erratic.	Sensor may be expired	Change the sensor.

Replacement Parts and Accessories

⚠ Warning

To avoid personal injury or damage to the detector, use only specified replacement parts.

To order any parts or accessories, contact [BW Technologies by Honeywell](#).

Table 15. Replacement Parts and Accessories

Model No.	Description	Qty
SR-X10	Replacement O ₂ sensor	1
PS-RM04H	Replacement CO sensor (low H ₂ sensitivity)	1
PS-RM04	Replacement CO sensor	1
PS-RH04S	Replacement H ₂ S sensor	1
SR-P04	Replacement PH ₃ sensor	1
PS-RS04	Replacement SO ₂ sensor	1
PS-RC10	Replacement Cl ₂ sensor	1
SR-A04	Replacement NH ₃ sensor	1
SR-A204	Replacement NH ₃ sensor (high range)	1
PS-RD04	Replacement NO ₂ sensor	1
PS-RZ10	Replacement HCN sensor	1
SR-E04	Replacement ETO sensor	1
SR-V04	Replacement ClO ₂ sensor	1
SR-G04	Replacement O ₃ sensor	1
SR-N04	Replacement NO sensor	1
GAXT-SS	Sensor screens	10

Model No.	Description	Qty
GA-TC-1	Test cap and hose	1
GA-BALERT	Concussion-proof boot	1
GA-BSPLASH-K	Splash guard filters	5
GA-HC-1	Hard hat clip	1
GA-AG-1	Alligator clip (non-conductive)	1
GA-AG-2	Alligator clip (stainless-steel)	1
GA-CL-1	Belt clip with screw	1
GA-NS-1	Neckstrap with safety release	1
GA-LY-1	Short strap (6 in./15.2 cm)	1
GA-USB2	IR DataLink	1

Specifications

Instrument dimensions: 2.8 x 5.0 x 9.5 cm
(1.1 x 2.0 x 3.75 in.)

Weight: 82 g (2.9 oz.)

Operating temperature:

H₂S, SO₂, HCN: -40°C to +50°C (-40°F to +122°F)

CO: -30°C to +50°C (-22°F to +122°F)

NH₃, NH₃ (high range): -20°C to +40°C (-4°F to +104°F)

Other gases: -20°C to +50°C (-4°F to +122°F)

Operating humidity:

CO, H₂S, SO₂, Cl₂, HCN, NO₂, NH₃, PH₃, ETO, NO, O₃:

15% to 90% relative humidity (non-condensing)

Cl₂: 10% to 95% relative humidity (non-condensing)

ClO₂: 15% to 95% relative humidity (non-condensing)

O₂: 0% to 99% relative humidity (non-condensing)

Detection range:

GasAlert Extreme O₂: 0 – 30.0% vol. (0.1% vol. increments)

GasAlert Extreme CO: 0 – 1000 ppm (1 ppm increments)

GasAlert Extreme CO (low H₂ sensitivity): 0 – 1000 ppm
(1 ppm increments)

GasAlert Extreme H₂S: 0 – 100 ppm (1 ppm increments)

GasAlert Extreme H₂S (high range): 0 – 500 ppm (1 ppm increments)

GasAlert Extreme PH₃: 0 – 5.0 ppm (0.1 ppm increments)

GasAlert Extreme SO₂: 0 – 100.0 ppm (0.1 ppm increments)

GasAlert Extreme Cl₂: 0 – 50.0 ppm (0.1 ppm increments)

GasAlert Extreme NH₃: 0 – 100 ppm (1 ppm increments)

GasAlert Extreme NH₃: (high range) 0 – 400 ppm (1 ppm increments)

GasAlert Extreme NO₂: 0 – 100.0 ppm (0.1 ppm increments)

GasAlert Extreme HCN: 0 – 30.0 ppm (0.1 ppm increments)

GasAlert Extreme ETO: 0 – 100.0 ppm (0.1 ppm increments)

GasAlert Extreme ClO₂: 0 – 1.00 ppm (0.01 ppm increments)

GasAlert Extreme O₃: 0 – 1.00 ppm (0.01 ppm increments)

GasAlert Extreme NO: 0 – 250 ppm (1 ppm increments)

Sensor type: Plug-in electrochemical cells

Calibration: Auto zero, set span, and span sensor

Alarm conditions: TWA alarm, STEL alarm, low alarm, high alarm, sensor alarm, low battery alarm, confidence beep, automatic shutdown alarm.

Audible alarm: 95 dB at 0.3 m (1 ft.) typical

Visual alarm: Red light-emitting diode (LED)

Display: Alpha-numeric liquid crystal display (LCD)

Backlight: Automatically activates for 3 seconds whenever there is insufficient light to view the display and during alarm conditions. Any pushbutton reactivates the backlight for 6 seconds.

Self-test: Initiated upon activation

Battery test: Every 0.5 seconds

Battery: Panasonic CR-2PE/BN battery

Warranty: 2 years including sensors.

Approvals:

Classified by UL to both U.S. and Canadian Standards as Intrinsically Safe for Class I, Division 1, Group A, B, C, D
European Explosives Protection EEx ia IIC

CE 0539  II 1 G DEMKO 04 ATEX 03 36363

IECEX

ABS Type Approved: VA-348-169-X

KTL: 12-KB4BO-0199X¹

EAC Certificate: RU C-GB.ГБ05.B.01115

Inmetro: Ex ia IIC T4 Ga DNV 12.0137 X

Ratings and Certifications

The GasAlertExtreme is in conformity with the following standards:

UL 913 8th Edition

CSA C22.2 No. 157-92:2012

EN 60079-0:2012 +A11:2013

EN 60079-11:2012

EN 60079-26:2007

IEC 60079-0:2011

IEC 60079-11:2011

IEC 60079-26:2006

General Specifications for Datalogger Units

Storage: Maximum of 8 months of data at 5 second intervals (based on a normal workweek).

Memory Type: Wrap-around memory ensures most recent data is always saved.

Sample Rate: One reading every 5 seconds (standard)

Data Recorded: All sensor readings, all alarm conditions, calibrations, event flags, battery status, sensor status, confidence beep activation, and detector status along with the time and date and the detector serial number.

Indicators: Icon advising datalogger is operating normally

Transfer Accessory: IR DataLink or other BW accessory

Support:

BW Excel Datalog Manager (EDM): This software organizes GasAlert Extreme datalog and event log files into a readable report

Fleet Manager CD Support: This software organizes GasAlert Extreme datalog and event log files into a readable report

-
1. [http://www.honeywellanalytics.com/~media/honeywell-analytics/products/gasalert-extreme/documents/certifications/koreanexcertifi-cate_bw_gaextreme_12kb4bo0199x-\(2\).pdf?la=en](http://www.honeywellanalytics.com/~media/honeywell-analytics/products/gasalert-extreme/documents/certifications/koreanexcertifi-cate_bw_gaextreme_12kb4bo0199x-(2).pdf?la=en)

This equipment has been tested and found to comply with the limits for a Class B digital device, pursuant to Part 15 of the FCC Rules and ICES-003 Canadian EMI requirements. These limits are designed to provide reasonable protection against harmful interference in a residential installation. This equipment generates, uses and can radiate radio frequency energy and, if not installed and used in accordance with the instructions, may cause harmful interference to radio communications. However, there is no guarantee that radio interference will not occur in a particular installation. If this equipment does cause harmful interference to radio or television reception, which can be determined by turning the equipment off and on, the user is encouraged to try to correct the interference by one or more of the following measures:

- Reorient or relocate the receiving antenna.
- Increase the separation between the equipment and receiver.
- Connect the equipment into an outlet on a circuit different from that to which the receiver is connected.
- Consult the dealer or an experienced radio/TV technician for help.

Wear yellow. Work safe.

125465 UM-EN-GAXT-K1

[English]

© BW Technologies 2016. All rights reserved.